



CEILING OR SOFFIT INSTALLATION

Thank you for purchasing CGP glass partition system!



Assembly Guide

Please feel free to call us
at **855 692 7860**
or email at **info@cgp.nyc**

Content

I. receiving, handling and safety instructions.....	2
II. parts and hardware list and necessary tools.....	3
III. pre-assembly.....	4
IV. wall assembly.....	4-6
V. door assembly.....	6
VI. glass assembly.....	7-8

I. RECEIVING, HANDLING AND SAFETY INSTRUCTIONS



PRECAUTIONS: The following precautions are recommended to protect aluminum materials against damage.



CHECK ARRIVING MATERIALS: Check Arriving Crate / Tube for external damages. In the event the packaging appears to have visual damage, make appropriate notes on the freight bill of landing. Make sure driver acknowledges the damage in writing. Please send us the signed paperwork and photos of damage to info@cgp.nyc, so we can assess damage, file the claim and send you replacement material.



HANDLE CAREFULLY: Wear rubber lined gloves. Carefully open the crate using screw gun. Unload glass panels, doors and aluminum profiles on the clean, dry surface. Do not lean against each other to avoid damage. Glass and doors must be stored vertically.



All aluminum materials stored at job site must be stored with adequate separation and not stacked directly onto the concrete floor slab to prevent materials from being damaged when handling. Cardboard wrapped or paper interleaved materials must be kept dry.



If you are opening the crate on the tailgate of the truck, please remember to remove the crate after it has been emptied. It is your responsibility – not the freight company.



PROTECT MATERIALS AFTER ERECTION: Do not remove protective wrapper until the end of construction project. Cement, plaster, terrazzo, other alkaline solutions and acid based materials used to clean masonry are very harmful to the finish and should be removed with water and mild soap IMMEDIATELY.



Be noted: The warranty will not apply to any part of the system that will be altered by the client after product delivery.

II. PARTS AND HARDWARE LIST AND NECESSARY TOOLS

Parts to be used during the installation process



CGP1 Aluminum Profile

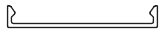

CGP4 Middle Cap



CGP5 Corner Cap

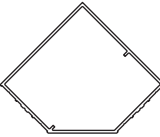

CGP8 Corner Aluminum Profile

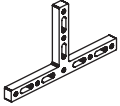

T20 T-Brackets

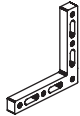

T21 L-Brackets

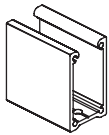

B20 Concealed Support Insert

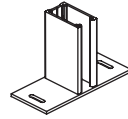

B30 Exposed Support Insert



C38 Middle PVC Clamp



C39 Corner PVC Clamp



G5 EPDM Profile Gasket (soft)



D1 EPDM Door Gasket (hard)



S10 Self Tapping Screws

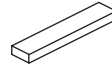

P10 PVC Glass Cushions

Tools and accessories required for installation

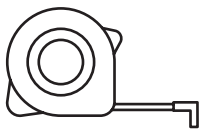

Tape measure



Level

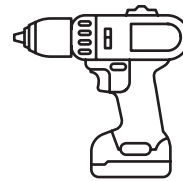

Screw gun

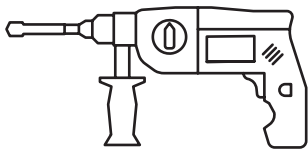

Drill

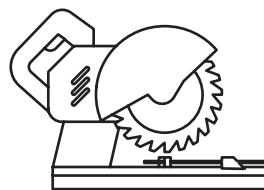

Miter saw (in the event of uneven surfaces)

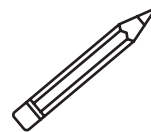

Pencil

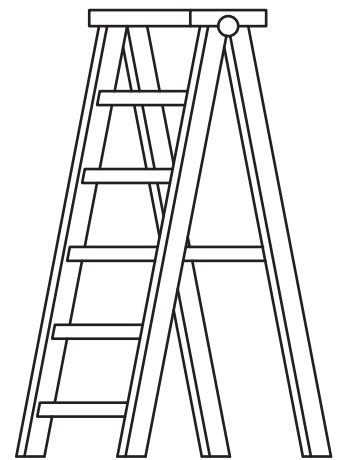

Ladder

III. PRE-ASSEMBLY



III.1. Unpack aluminum profiles.

III.2. Lay profiles on the floor with labels facing up.

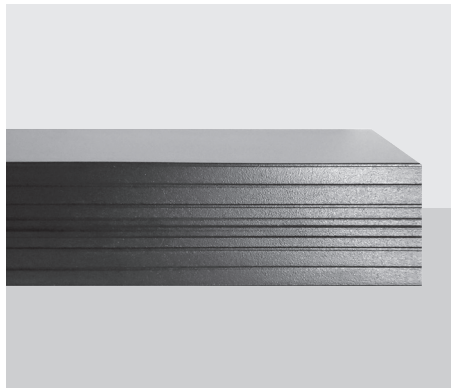

III.3. By default, grooved side of profile is considered **the outside** unless specified otherwise.

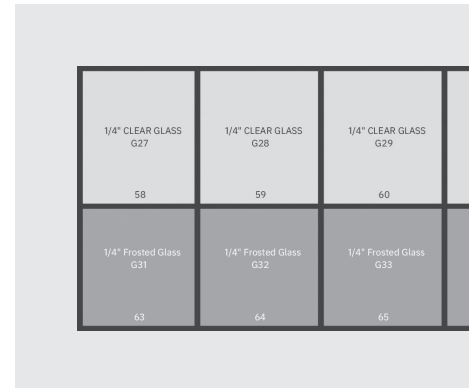

III.4. Lay out the profile grid on the floor using provided elevation drawings. Make sure numbers on profiles match with numbers on the drawings.

IV. WALL ASSEMBLY

1st section to assemble

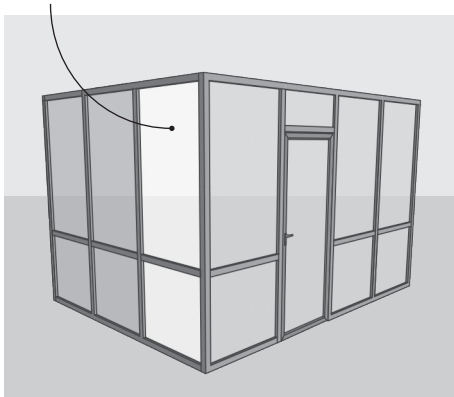

IV.1. Start to assemble with the section of the wall on the side adjacent to the **90-degree angle** of the partition system.

1st section to assemble

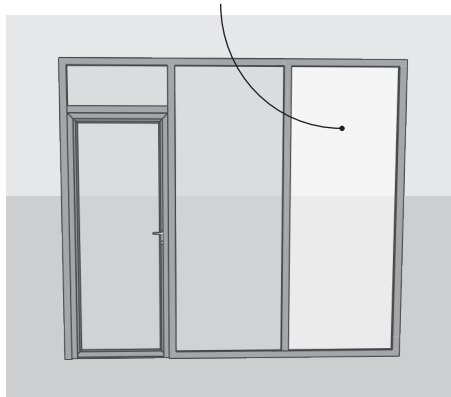

IV.2. In case the partition system has **no 90-degree angles**, start to assemble with the section of the wall on the far left or far right side.

IV.3. Draw 2 parallel reference lines on the floor $\frac{5}{8}$ inches apart, using a tape measure and a level.

Front line will represent finished glass wall installation location. Back line represents installation location of vertical profiles.

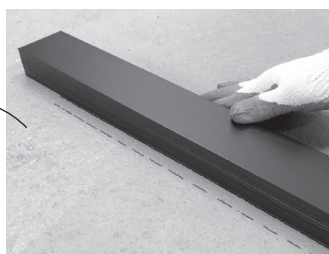
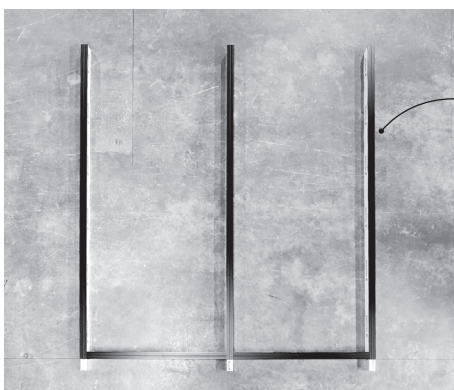

IV.4. Lay out profiles on the floor against the **BACK LINE** with profiles laying over the front line as shown on the picture to determine exact installation location of **B20 Concealed Support Bracket** mounting location.

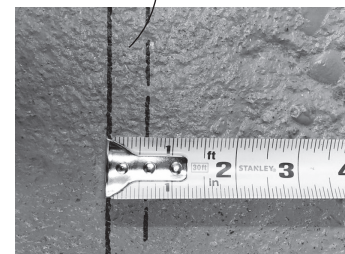



IV.5. Insert **F10 Floor Bracket Setup** into **B20 Concealed Support Insert** as shown.

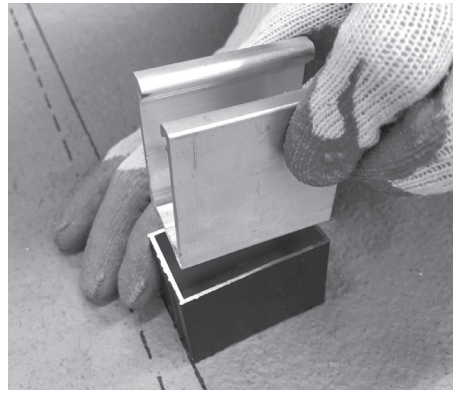

IV.6. Place on the back reference line as shown. Align the sides.

IV.7. Mark the center of each hole on the floor.

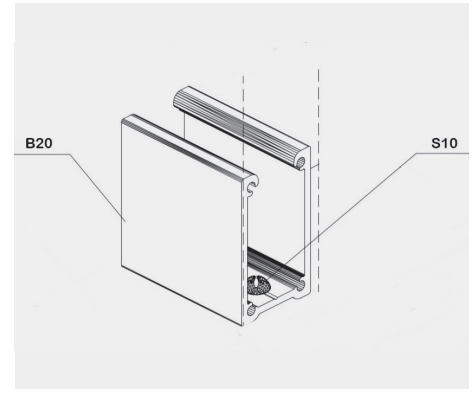

IV.8. Fasten **B20 Concealed Support Insert** to the floor with fasteners of your choice.

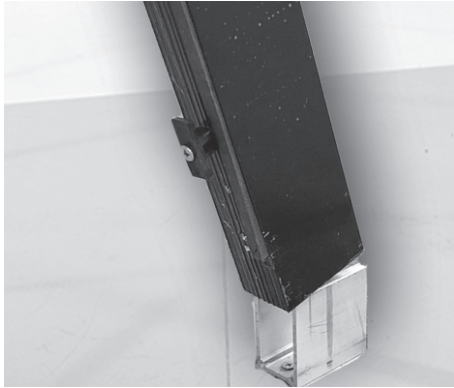

IV.9. Install vertical profiles as shown in the photo.



IV.10. Using **F10 Floor Bracket Setup** mark screw location.

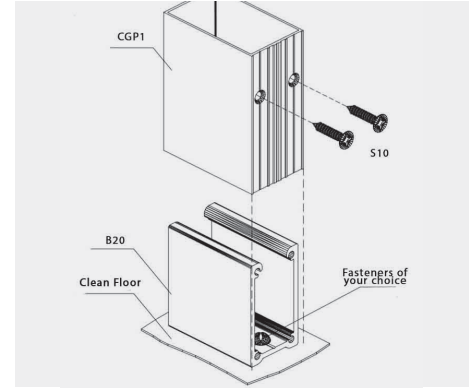

IV.11. Fasten the vertical profiles from the grooved side to the **B30 Exposed Support Insert** using "**S10 Screws**".

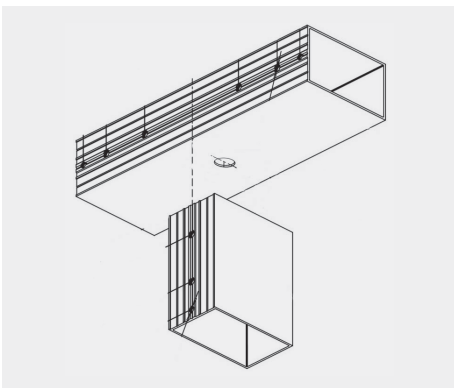

IV.12. Align the top horizontal beam with the reference line on the ceiling. Mark the center of the vertical beam on the bottom side of the top horizontal beam to drill the holes. The holes should be located in the places the vertical profile meets horizontal beam as shown in the photo.



IV.13. Pre-drill $\frac{1}{2}$ holes on the bottom side of top horizontal profile. Be careful not drill through the top side of the profile.

IV.14. Attach the top horizontal profile to the soffits using fasteners of your choice through the pre drill $\frac{1}{2}$ ' fastener hole.



IV.15. Gently bend vertical profile to expose the $\frac{1}{2}$ fastener hole and fasten the horizontal profile to the ceiling using fasteners of your choice.

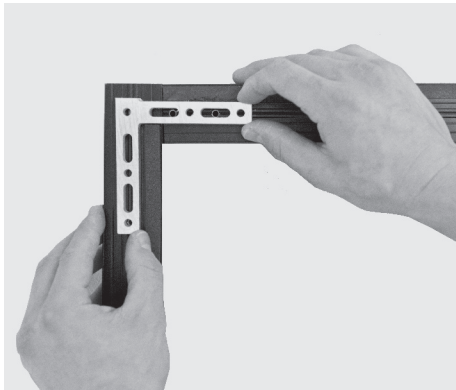

IV.16. Attach the vertical profile to the horizontal beam using T-Brackets and L-Brackets as shown in the photo.

IV.17. Continue with the next vertical profiles.



IV.18. Attach lower horizontal profiles along the way.

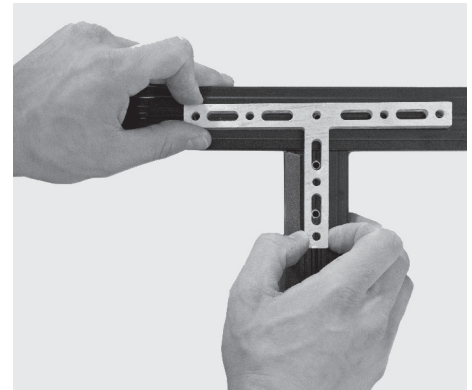

IV.19. Once the verticals are up, install the middle horizontal profiles using T-Bracket and Screws.

V. DOOR ASSEMBLY



V.1. Attach the **D1 EPDM Door Gasket** to the aluminum profile on both sides and top of the door opening.

Separate the door from the jamb and take the door off the hinges.



V.2. Install the Jamb into the opening and make sure it fits correctly and is level. Pull back the jamb few inches and remove blue protective strip from the door seal. Once the strip is off apply pressure to set the jamb in place. Make sure it is level.



V.3. Remove black rubber gasket from the inside of the door jamb.



V.4. Check the level one more time and fasten the jamb to aluminum profile using **S10 Screws**.



V.5. Place black rubber gasket back in place concealing the screw heads.

VI. GLASS ASSEMBLY

VI.1. Make sure that **T20 T-Brackets** and **T21 L-Brackets** are firmly fastened using **4 S10 Screws per bracket**.



VI.2. Install **G5 Epdm Profile Gasket** on all sides of profile that will have the glass installed.

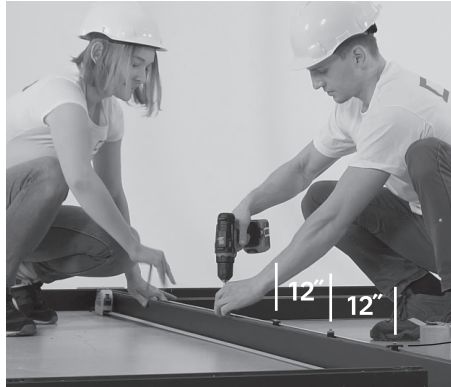

VI.3. Install **C38 Middle Clamp** every 12" on the profiles that will have glass on both sides. Do not tighten the **S10 Screws**, make sure you can turn the clamp freely with your fingers.

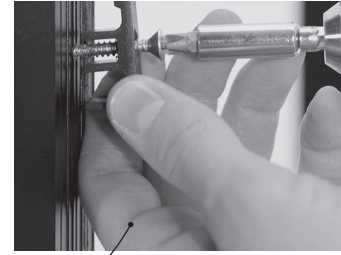

C38 Middle Clamp

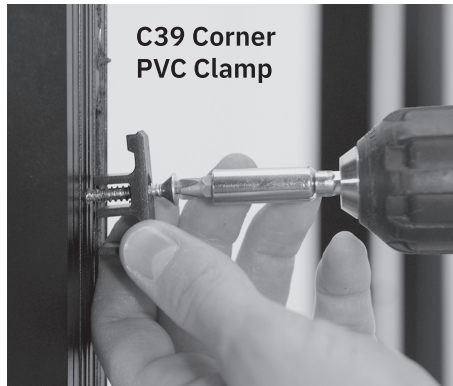

C39 Corner PVC Clamp



VI.4. Install **C39 Corner PVC Clamps** every 12" on the profiles that will have glass on one side. Do not tighten the **S10 Screws**, make sure you can turn the clamp freely with your fingers.

VI.5. Place **P10 Glass Cushions** on the **T20 T-Brackets** as shown. This insures that there is no direct glass to metal connection anywhere.



VI.6. Using rubber lined gloves or vacuum suction caps (if available) place the glass against the opening and rest it on the **P10 Bushings**.

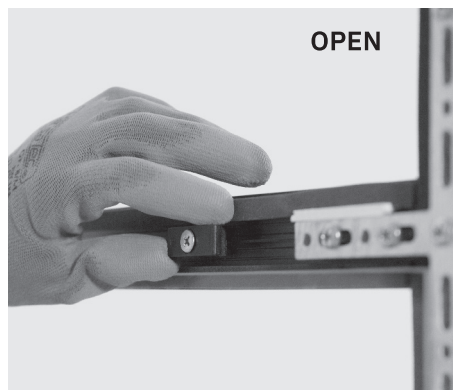

OPEN



CLOSED

VI.7. Close all the **PVC clamps** to hold glass in place. Tighten the screws with screw gun once closed.



VI.8. Snap **CGP5 Corner Caps** and **CGP4 Middle caps** on the **C38 Middle PVC Clamps** and **C39 Corner PVC Clamps**.



Please feel free to call us at **855 692 7860** or email at **info@cgp.nyc**



 **VIDEO GUIDE**

